

ADS Conveyor Table Limit Switch Kit #288-1044



The purpose of the table limit switch is to keep a conveyor dishmachine from operating continuously when racks reach the end of the clean table and then back up into the machine. This condition will increase chemical and energy usage. When tables are too short or the staff is not able to remove racks rapidly, the installation of the table limit switch is recommended.



DANGER

The electrical power supplied to this machine is an imminent hazard that could result in severe bodily injury or death if not properly installed or hooked up correctly. **When working in the control box or on electrical parts, always disconnect power and tag-out before servicing. Replace cover to control box and other protective covers when finished servicing this equipment.**



CAUTION

READ Manufacturer's Instructions before installing this Product. For your safety read and observe all cautions shown throughout these instructions. While performing installations described in this booklet, wear approved Personal Protective Equipment, including Safety Eye-Wear.

Installation of the Table Limit Switch

- 1) Determine the approximate centerline of the dishrack as it travels down the clean table.
- 2) Use caution ⚠ when cutting or drilling stainless steel, sharp or flying shards can injure or blind. Place the template (supplied in the kit) with the lower (two holes Copyright ADS Table Limit 3/2016 closest together—see drawing) edge resting on the table surface, against the end roll, and centered along the dishrack's line of travel. Mark the four hole positions using a center punch. Then drill a 1/8" hole through each position, the two lower holes are then drilled to 3/8" and the upper two holes are drilled out to 1/2".
- 3) Table preparation: the table role must be a minimum of 1-1/2" dia. for clearance of the switch. If it is less, the roll will need to be relieved by grinding, cutting, or bending. The template will set the correct elevation as long as the lower edge is setting on the table surface. After the template is used to mark the hole positions, the template can be discarded.
- 4) After the holes have been drilled, remove the switch *Bumper* by taking the two clip *Pins* out and sliding the bumper out of the hinged *Tilt Plate*. Loosen the wing nut on the *Switch Mount* and slide the switch *Shuttle* up and off the mount. From the outside, place the mount through the two (3/8") lower holes in the table and tighten the locking nuts on the two studs of the mount. Insert the bumper through the upper (1/2") holes and into the activator plate. Put on the clip pins to secure the bumper. If the bumper interferes with the holes on the table, loosen the locknuts on the studs and reposition the mount for clearance.
- 5) Take the switch shuttle and attach appropriate length of conduit between the control box and the table limit switch. Run two wires through the conduit and attach one to the COMMON terminal on the table limit switch, attach the other to the normally OPEN terminal. Then attach the other ends of the two wires to the 110v terminal (black wires) located in the lower left-hand corner of the control box.

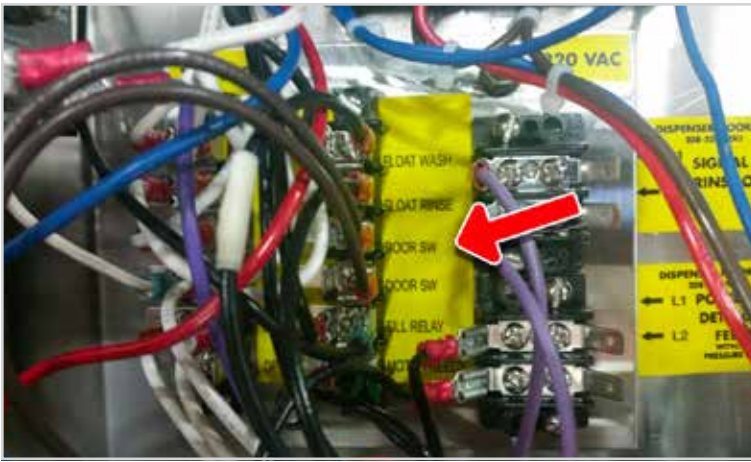

Lower left corner of the conveyor control box

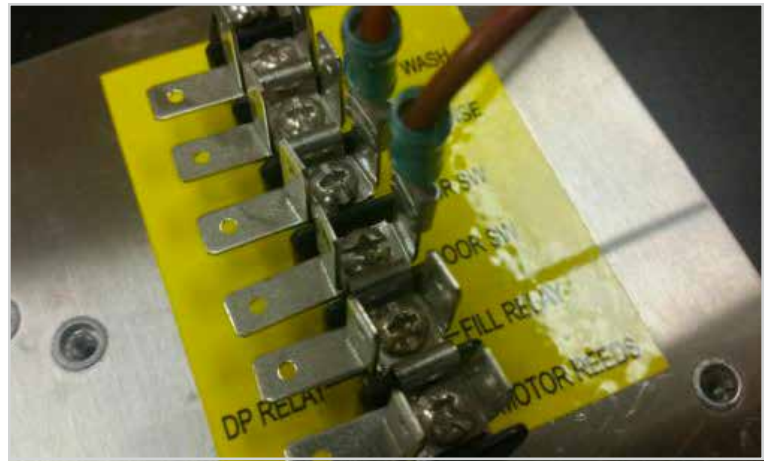

Locate top brown wire on terminal strip

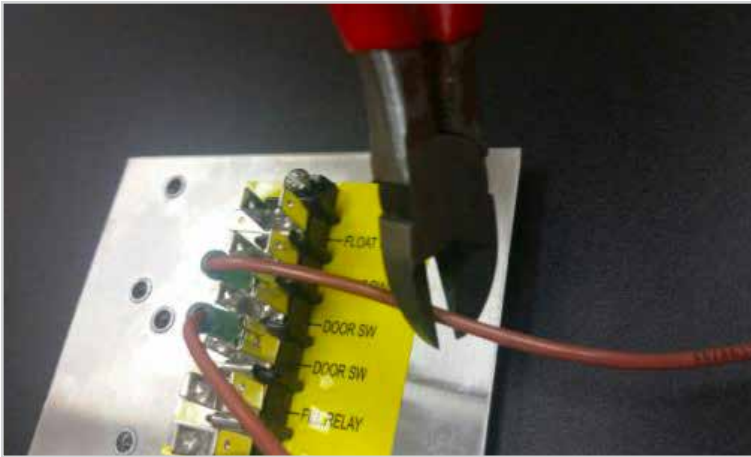

Cut the top brown in two

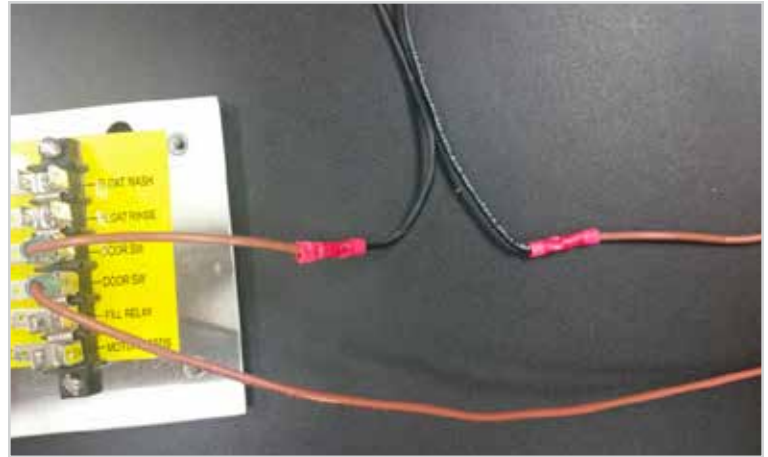

Connect wires from table limit switch to open wires of brown completing the loop



Showing 7/8" hole in the control box for conduit, if more are required for feeders and table limit, a second hole will be needed.

6) It is IMPORTANT to observe the positions of the attachment. The terminal block is divided into two separate parts, a north and south division. The terminal block is divided by the removal of a jumper tab located at the center. The door cut-off switch is attached by two brown wires to these separated terminals. Take that top brown (labeled Door SW) and cut in two, connect the wires coming from the table limit switch to the two open wires produced when the brown wire was cut to close the loop.

NOTICE

Important: In order to avoid delay of final rinse when the machine starts up after the table limit switch is released (by removing a rack from the table), disable the final rinse time-delay relay. The final rinse relay is located on the left-hand side of the control box. The switch is disabled by joining the blue and purple wires together.

7) The use of the table limit switch can save unnecessary expense in resources. There are some points to be aware during the installation. If the holes are binding on the bumper's return this will cause the machine to turn off. The bumper should be easy to depress and return to normal position. The table must have enough space for the switch and shuttle behind the table roll (1.5" min). The shuttle must be attached and secured in the mount with the wing nut.

ADS Table Limit Switch

Place in center line of rack direction

Kit # 88-1044

Disable

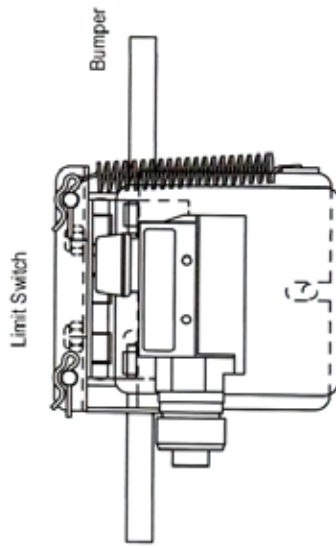
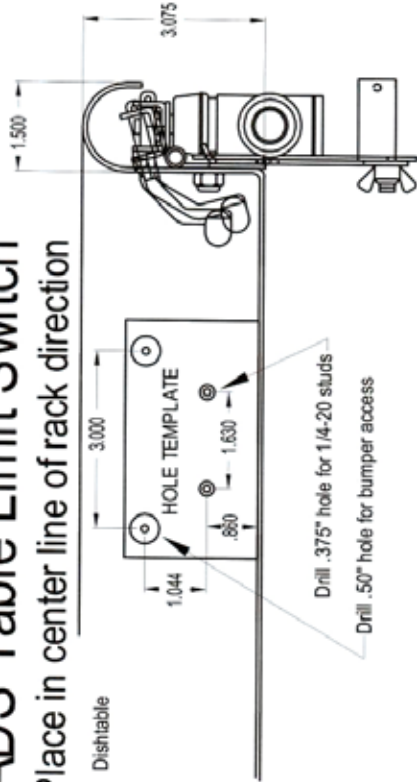

ADC Control Box

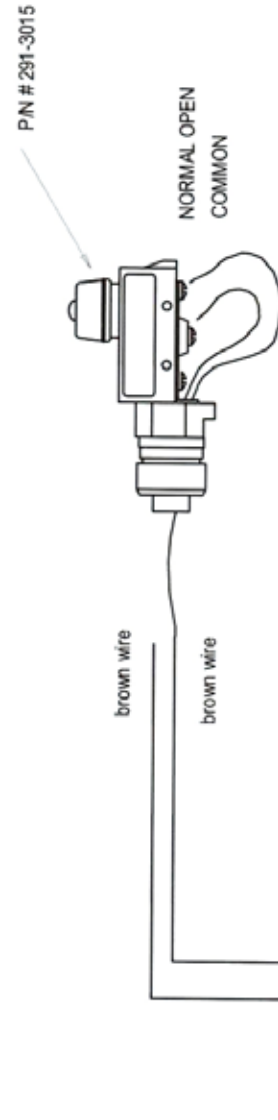

Connect to one of the Door Cut-off wires as shown



Door Cut-off Switch
Normal-Open

ADSpayzant/12.6.00



American Dish Service

**Manufacturer of low and high temperature Commercial
Dishwashers and Glasswashers**

© American Dish Service

900 Blake Street | Edwardsville, Kansas, 66111
913.422.3700 | Toll-Free: 800.922.2178 | Fax: 913.422.6630
orders@americandish.com | **americandish.com**

